

TABLE OF CONTENTS

INTRODUCTION

<i>Application</i>	2
<i>Specifications</i>	2
<i>Features</i>	2
<i>General system overview</i>	3
<i>Installation Procedure</i>	4
<i>System Wiring Diagrams</i>	7
<i>Wiring the Detectors</i>	14

PROGRAMMING

<i>Power Up procedure</i>	16
<i>Manual Programming procedure</i>	17
<i>Touchpad Programming</i>	19
<i>Programming From the CS-4000</i>	22

SYSTEM OPERATION

<i>Protection Levels and Operating Instructions</i>	25
<i>System alarm and status sounds</i>	29
<i>Understanding the display</i>	30
<i>Special Features</i>	31
<i>Command and Memory Buttons</i>	31
<i>Changing Access Codes</i>	31
<i>Emergency Alarm Buttons</i>	31
<i>Light Control</i>	31
<i>Chime Feature</i>	31
<i>Zone Bypassing</i>	31
<i>Touchtone™ Telephone Arming</i>	32

TESTING

<i>Protection Level Test</i>	33
<i>Communications Test</i>	33
<i>Sensor Test</i>	33
<i>Phone Test</i>	33
<i>Alarm Memory Test</i>	33
<i>Stand-by Power Test</i>	33

Application

The Commander is a multi-zone self-contained, touchpad programmable security control system with a built-in digital communicator and piezo siren. The security system and its accessories were designed to detect, control, and communicate alarms and other activities for commercial and residential applications. The Commander is pre-programmed at the factory and ready for installation.

Specifications

- Attractive control panel with built-in touchpad, system and zone status indicator LEDs, and piezo siren.
- Control panel dimensions: 6-3/4" wide x 4-3/4" high x 1" deep.
- Installs in triple gang outlet box or directly on wall.
- Four, 2-wire intrusion detection zones.
- One fire zone with 4,700 ohm end of line resistor for supervision.
- Six LEDs provide total system and zone status.
- A built-in panic button for Police.
- A built-in panic button for Fire.
- A built-in panic button for Emergency.
- Output for an optional Burglar Alarm Interface Module, from X-10 to control lights.
- Five-digit account number.
- (2) Separate fourteen digit (max.) Central Station phone numbers. Digits can include pauses.
- Touchtone telephone police panic alarm when an optional Telephone Control Module is installed.
- 9 Volt Alkaline Energizer back-up battery, or optional 9V Lithium, or rechargeable 9V NiCad battery.
- Built-in switchable battery charging circuit.
- 9 VAC, 15 VA, Plug-in Class II transformer (UL Listed) (CSA Approved).
- Seven stage lightning/transient protection.
- Automatic 24-hour dynamic battery test.
- Unpluggable circuit board.

- 12 VDC Accessory Power
- 150 mA Maximum current available for accessories.

Features

- All functions are touchpad programmable.
- Completely interactive capabilities.
- 24 hour system status supervision.
- User phone test.
- 1 to 84 day programmable automatic phone test.
- User sensor test.
- Light Control output activates on command, during alarms, and during exit and entry delays.
- Every Touchtone phone on premise can be an arming station when an optional Telephone Control Module is installed.
- Audible status signals from telephones when an optional Telephone Control Module is installed.
- Duress Code to signal need for help without alerting intruder.
- 6 User Access codes; one primary. The five remaining codes are for optional auxiliary use.
- Open/Close reports tell the Central Station when your system is accessed and closed by user number.
- The Quick Arm feature allows you to upgrade your protection level without reprogramming the entire code.
- In case of emergency, your system can be programmed to dial a second central monitoring station if for any reason the first one cannot be reached.
- Remote programming and diagnostics from the CS-4000 Central Station Receiver.
- Individual Zone Bypassing from Control Panel.

SYSTEM OVERVIEW

General

The Commander Self Contained Control Panel is ready to use from the factory. It comes pre-programmed with three Burglar zones, one audible Police Panic, one Fire zone, and three Touchpad emergency zones. No special prom programmer or bar-code reader is required to take advantage of the control's many features. If the default settings described below do not meet your installation requirements, they can easily be changed from the touchpad. The following is a list of the system features and their default settings from the factory.

Zone Definitions

*Zone 1: Intrusion-Delay, Normally Closed, alarm on open (Exterior)
Zone 2: Intrusion-Instant, Normally Closed, alarm on open (Exterior)
Zone 3: Intrusion-Instant, Normally Closed, alarm on open (Interior)
Zone 4: Audible Police-Panic, Normally Open, close on alarm
Zone 5: Fire (24 Hour), Normally Open, alarm on close*

User Identifications

*Primary Access Code - 1-2-3-4 From System Touchpad
1-2-3-4 From Touchtone Phone if Telephone Control Module is installed.

Auxiliary Access Code 2-6 - Available, not programmed.

Account number - 00000

Primary Central Station Phone Number - None (all nulls)

Secondary Central Station Phone Number - None (all nulls)

Timed Features

Exit delay - 30 seconds

Entrance delay - 30 seconds

Siren timeout - 4 minutes

Light control - 15 minutes

during entry/exit delays- 100 seconds

Zone response time -200 milliseconds

Automatic phone test - Disabled

Touchtone start response time-128 milliseconds

Back-up Battery Test - Every 24 Hours

AC Power loss report to CS-4000 - 15 minutes

Electrical Considerations

Detection and accessory devices must operate between 6-12 VDC.

Maximum allowable current draw is 150 mA (all accessories combined).

INSTALLATION PROCEDURE

Before attempting to install the Commander Control panel, read through this Installation Manual and the Commander Users Manual very thoroughly. An understanding of how the system operates and all of its features is essential.

STEP 1: Plan the installation

- *Discuss the installation requirements and applications with the user.*
- *Physically survey the installation requirements.*
- *Compare the installation requirements with the pre-programmed zones and features.*
- *Where possible, layout the system to conform to the factory program so that installer programming is minimized.*

STEP 2: Installing the system

- *The Commander Control Panel was designed to be mounted in a triple gang electrical box. If this is not practical, the panel can also be mounted directly to a wall using the mounting plate provided, securing it with the four outermost slots.*

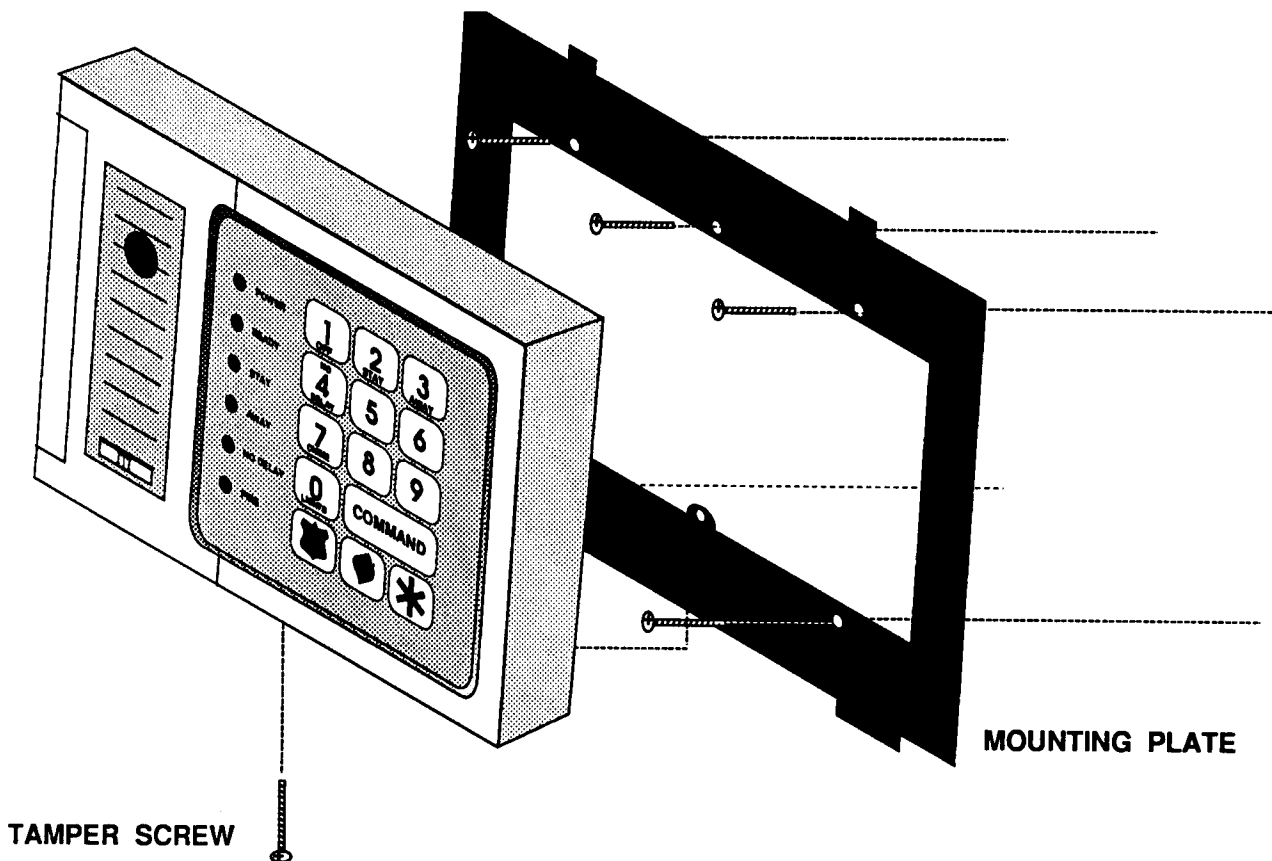

- Install all other security devices as per the manufacturer's specifications. It is recommended that the number of fire detectors installed per system does not exceed five (5). An 4.7K EOL (end of line) resistor is supplied with the system installed on the fire zone leads. If you are adding fire detectors to the system, cut the fire zone leads half way between the resistor and the connector and reconnect the resistor after the last detector in the zone. If no fire detectors are in the installation, program the Fire Zone disabled.

- Complete the hardware installation and all other optional system components. The following is a list of all of the detection sensors and optional components that can be used with the Commander.

Detection sensors	Part Numbers	N/O or N/C	Max Quantity	Current
Smoke/Heat Detector	13-077	N/O	5 per zone	1.5 mA
Heat Detectors-Rate of Rise	Available Soon	N/O	5 per zone	none
Misc Magnetic Switches	13-065 thru 13-074	N/C	5 per zone	none
Sound Detector	60-139	N/C	2 per zone	60 mA
Passive Infrared	13-082	N/C	3 per zone	100 uA
Glass Break Detector	13-062	N/C	5 per zone	none
Manual Emergency Button	13-075	N/C	5 per zone	none

Sirens

Outside Siren	13-046		1	100 mA
Phone Jack/Siren	60-108		2	12 mA
Hardwire Interior Siren	60-278		1	75 mA

Optional Components

Telephone Control Module	60-271		1	
X-10 Burglar Alarm Interface	13-058		1	
X-10 Wall Switch Module	13-057		1	
X-10 Lamp Module	13-049		1	
RJ31X Jack	13-081		1	none

- Carefully label all wiring in system.

NOTE: Be sure to terminate ALL wire leads NOT in use at the connector plug.

NOTE: Maximum current available for all accessory devices is 150 mA

NOTE: If a Telephone Control Module is installed or the system is to be monitored by a central station, an RJ31X Wiring Harness (packed with the system) and an RJ31X Jack MUST be installed with the system according to the wiring diagram in this manual.

STEP 3: Programming the control panel

- *Use the programming section in this manual to guide you through customizing your installation.*
- *Be sure to document any variations made to the original factory set program.*

STEP 4: Testing the equipment

- *Perform all functional tests on the system outlined in the test section of this manual.*

STEP 5: Educating the user

- *Walk the user through the system, explaining to them all the different devices used in the installation.*
- *Using the Commander Users Manual that is provided as a guide, walk the user through each protection level explaining what each means.*
- *Explain to them how to interpret the LED display.*
- *Show the user all of the optional features that are unique to the installation.*
- *Show them how to use all of the features included in their system.*
- *Fill out the Installation Record with the user.*

WIRING DIAGRAMS

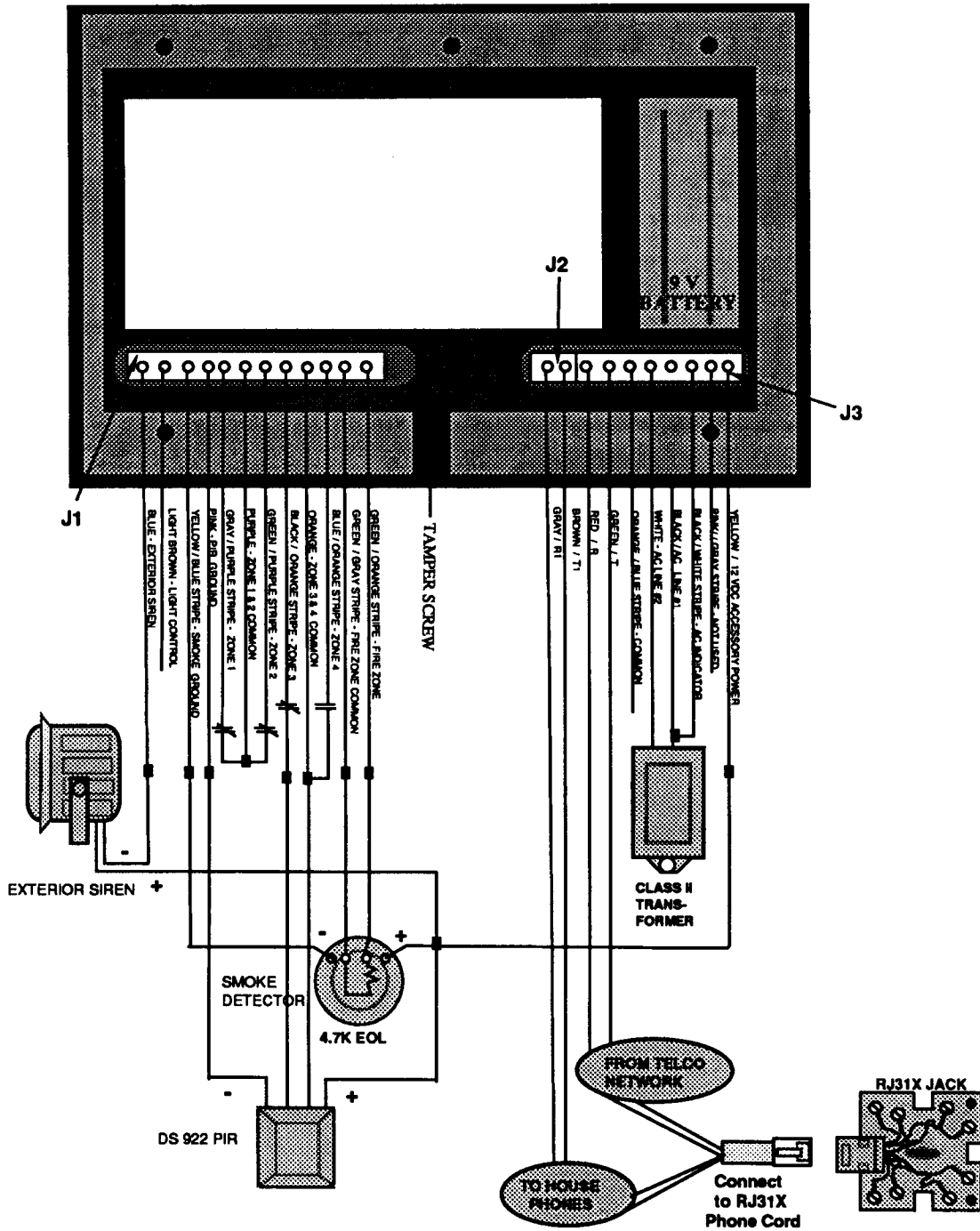

**WIRING HARNESS COLOR CODING
ON COMMANDER CIRCUIT BOARD
WITHOUT TELEPHONE CONTROL MODULE**

J1

EXTERIOR SIREN..... BLUE
LIGHT CONTROL..... LIGHT BROWN
SMOKE GROUND..... YELLOW /BLUE STRIPE
PIR GROUND..... PINK
ZONE 1..... GRAY /PURPLE STRIPE
ZONE 1 & 2 COMMON..... PURPLE
ZONE 2..... GREEN /PURPLE STRIPE
ZONE 3..... BLACK /ORANGE STRIPE
ZONE 3 & 4 COMMON..... ORANGE
ZONE 4..... BLUE /ORANGE STRIPE
FIRE ZONE COMMON..... GREEN /GRAY STRIPE
FIRE ZONE..... GREEN /ORANGE STRIPE

J2

RING (TO HOUSE PHONES)..... BROWN
TIP (TO HOUSE PHONES)..... GRAY

J3

RING (FROM TELCO)..... RED
TIP (FROM TELCO)..... GREEN
COMMON..... ORANGE /BLUE STRIPE
AC LINE #2..... WHITE
AC LINE # 1..... BLACK
AC VOLTAGE INDICATOR..... BLACK /WHITE STRIPE
NOT USED..... PINK /GRAY STRIPE
12 VDC ACCESSORY POWER..... YELLOW

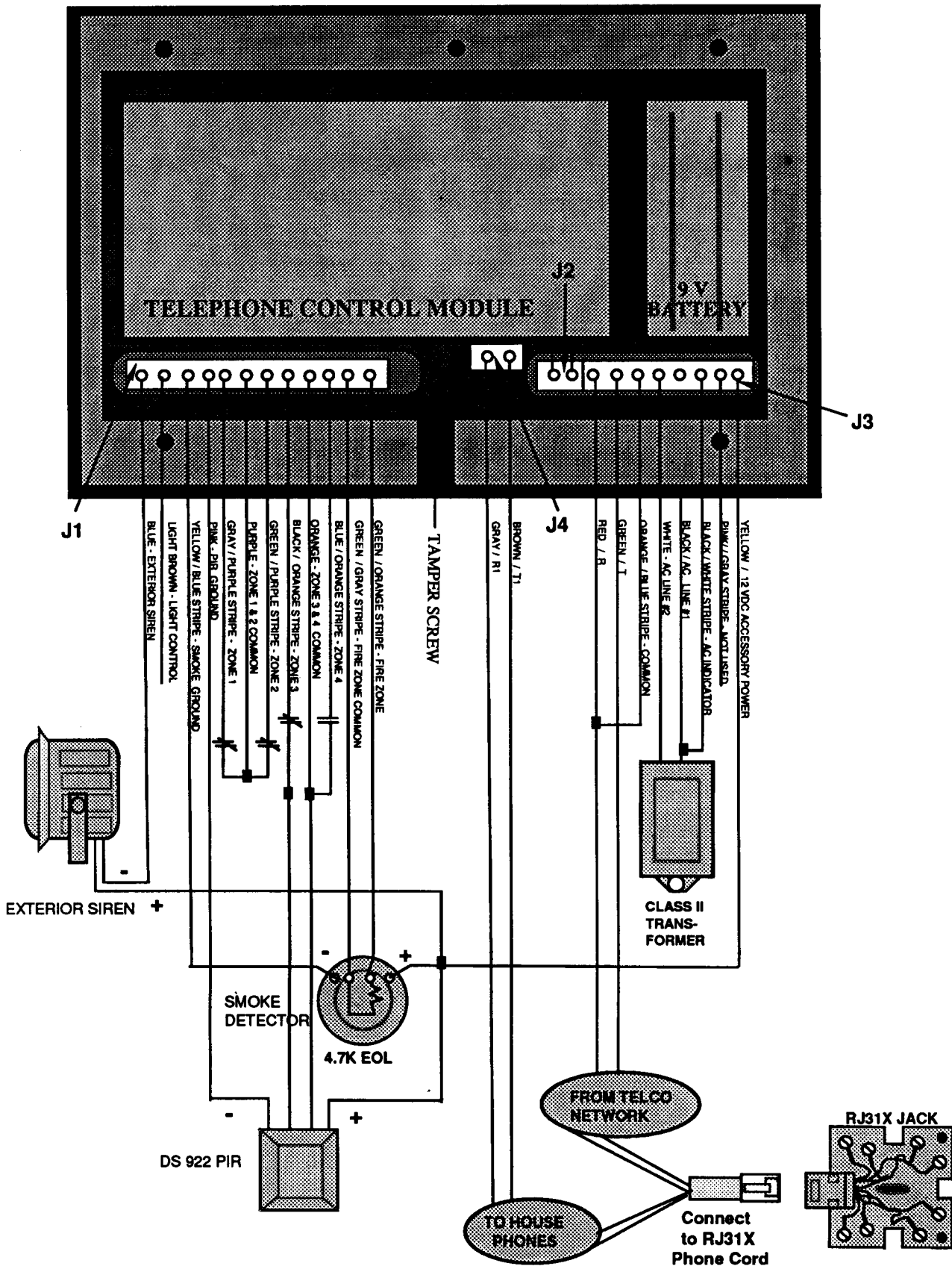

WIRING HARNESS COLOR CODING ON COMMANDER CIRCUIT BOARD WITH TELEPHONE CONTROL MODULE

J1

EXTERIOR SIREN.....	BLUE
LIGHT CONTROL.....	LIGHT BROWN
SMOKE GROUND.....	YELLOW /BLUE STRIPE
PIR GROUND.....	PINK
ZONE 1.....	GRAY /PURPLE STRIPE
ZONE 1 & 2 COMMON.....	PURPLE
ZONE 2.....	GREEN /PURPLE STRIPE
ZONE 3.....	BLACK /ORANGE STRIPE
ZONE 3 & 4 COMMON.....	ORANGE
ZONE 4.....	BLUE /ORANGE STRIPE
FIRE ZONE COMMON.....	GREEN /GRAY STRIPE
FIRE ZONE	GREEN /ORANGE STRIPE

J4 - ON TELEPHONE CONTROL MODULE

RING (TO HOUSE PHONES).....	GRAY
TIP (TO HOUSE PHONES).....	BROWN

J2

RING (TO PANEL CONNECTOR).....	GRAY
TIP (TO PANEL CONNECTOR).....	BROWN

J3 - ON PANEL CIRCUIT BOARD

RING (FROM TELCO NETWORK).....	RED
TIP (FROM TELCO NETWORK).....	GREEN
COMMON.....	ORANGE /BLUE STRIPE
AC LINE #2.....	WHITE
AC LINE # 1.....	BLACK
AC INDICATOR.....	BLACK /WHITE STRIPE
NOT USED.....	PINK /GRAY STRIPE
+12 VDC ACCESSORY PWR.....	YELLOW

TELEPHONE CONTROL MODULE

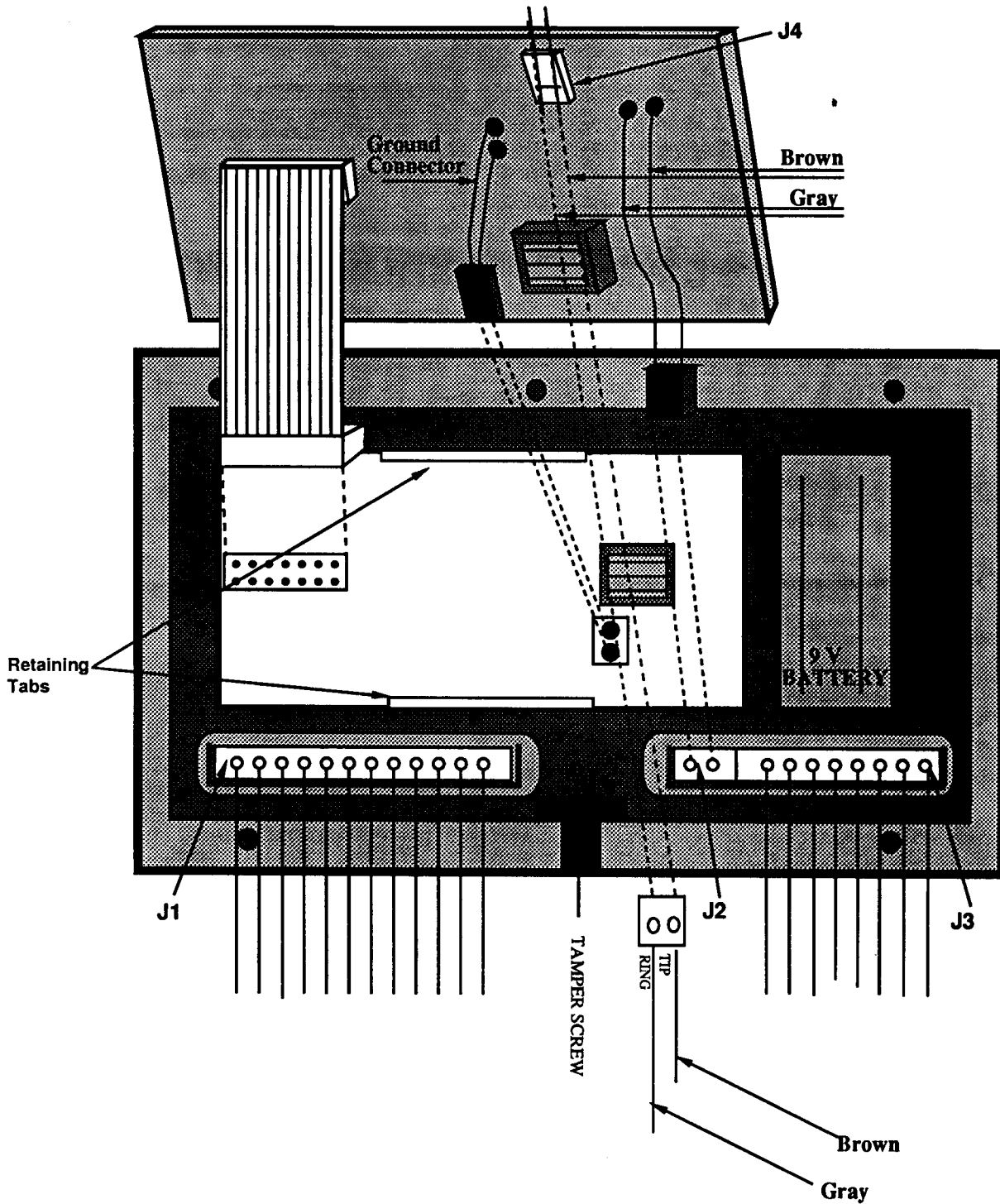

NOTE: When installing a Telephone Control Module, be sure all connections are good and the circuit board is snapped securely in place under the retaining tabs on the Control Panel.

NOTE: AN RJ31X JACK MUST BE INSTALLED ANY TIME THE OPTIONAL TELEPHONE CONTROL MODULE IS INSTALLED OR IF THE SYSTEM IS TO BE MONITORED BY A CENTRAL STATION.

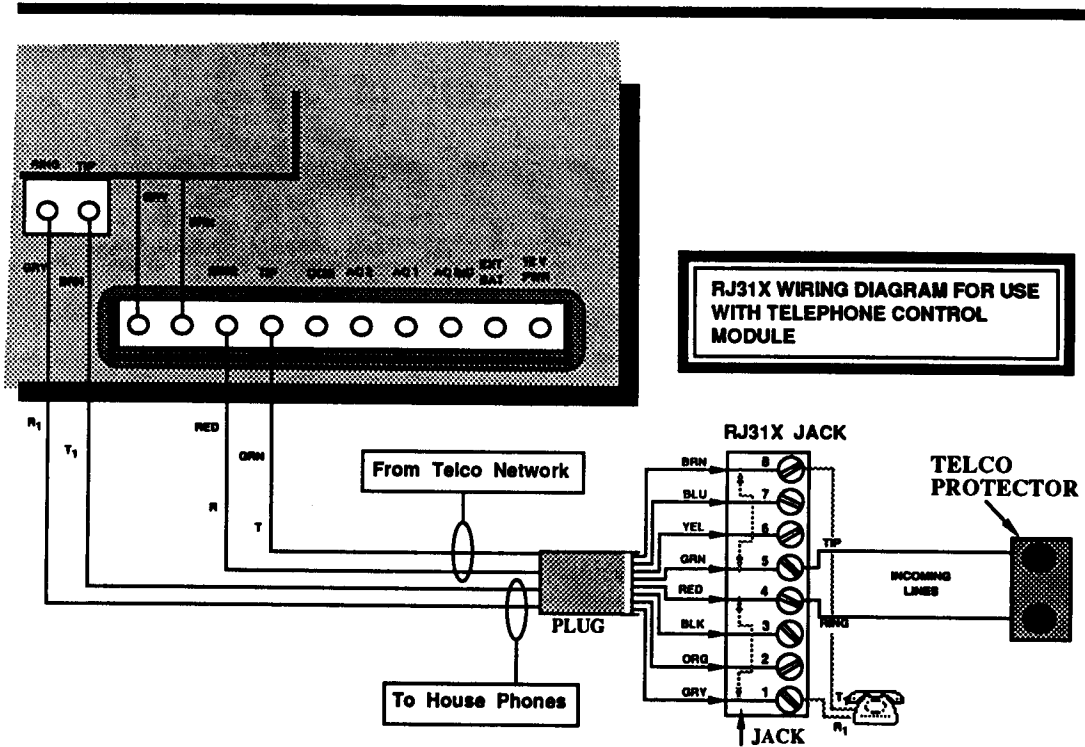
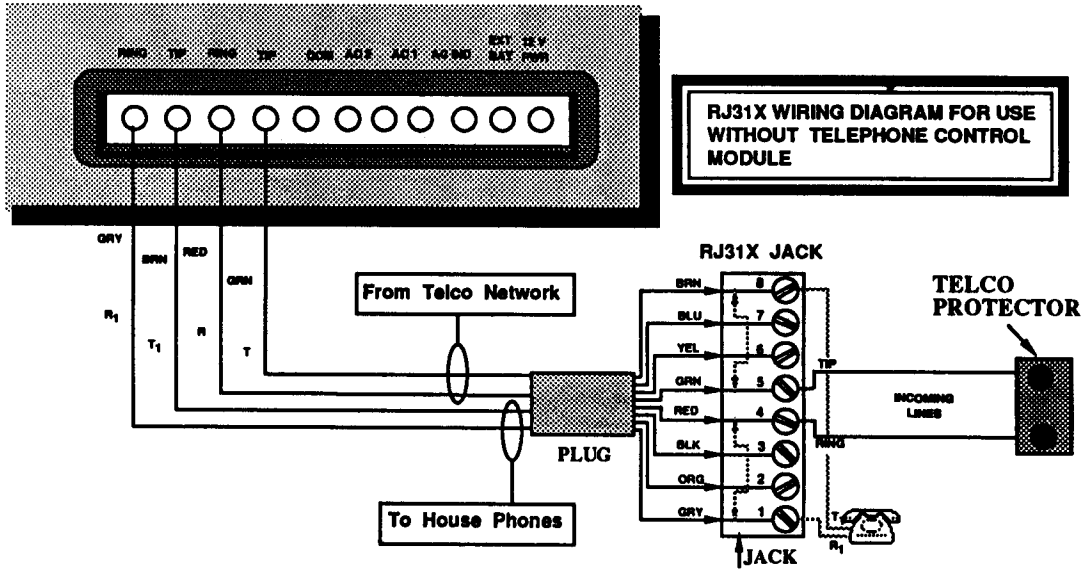

WIRING DIAGRAM FOR USE WITH X-10 POWERHOUSE BURGLAR ALARM INTERFACE MODULE TO CONTROL LIGHTS

NOTE:

TO ALLOW THE COMMANDER TO CONTROL THE LIGHTS:

SET INPUT TO B (DRY CONTACT CLOSURE)

SET MODE TO 1 (ALL LIGHTS ON AND UNIT CODE ON)

SET UNIT CODE ON ALL LIGHT CONTROL MODULES TO THE SAME CODE AS THE BURGLAR ALARM INTERFACE MODULE

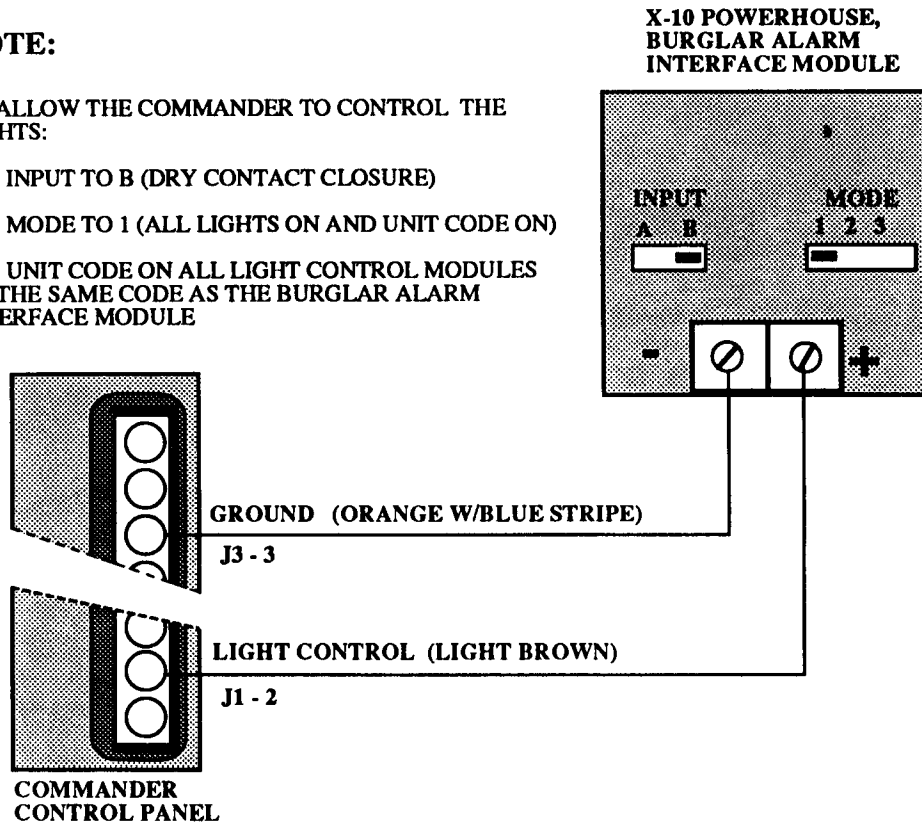

WIRING THE DETECTORS

When wiring peripheral components to the Commander, you should always consider whether the device has a Normally Open or Normally Closed switch.

Normally Closed

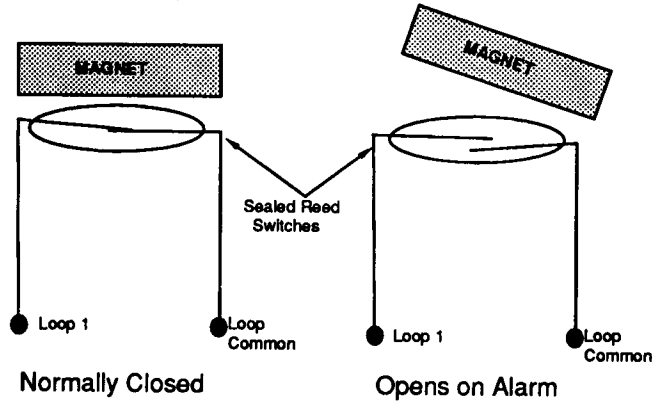

Normally Open

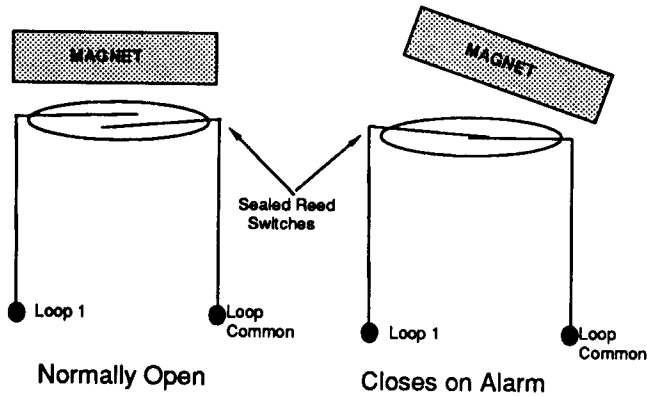

Of the components available from ITI for the Commander, only the Smoke, Heat detectors, and Panic buttons are Normally Open; all others are Normally Closed.

Normally Closed switches should be wired in series:

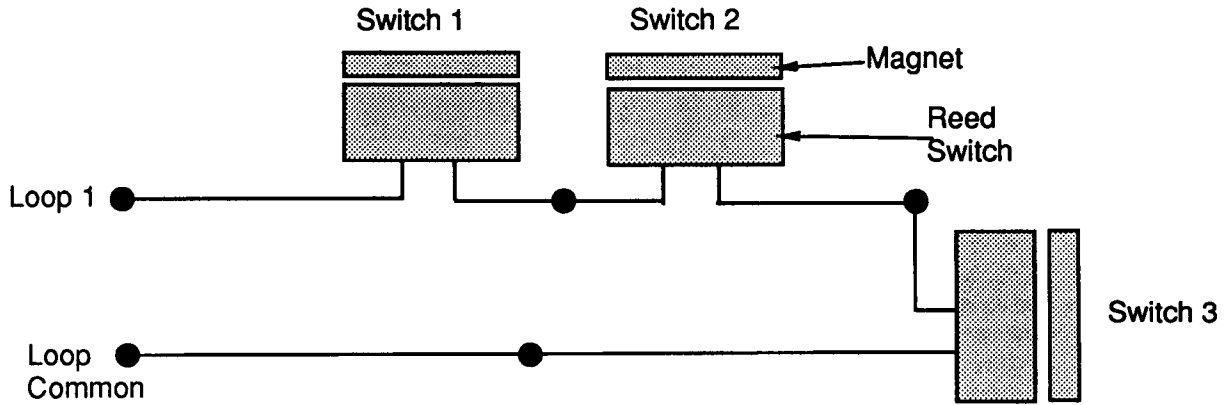

Normally Open switches should be wired in parallel:

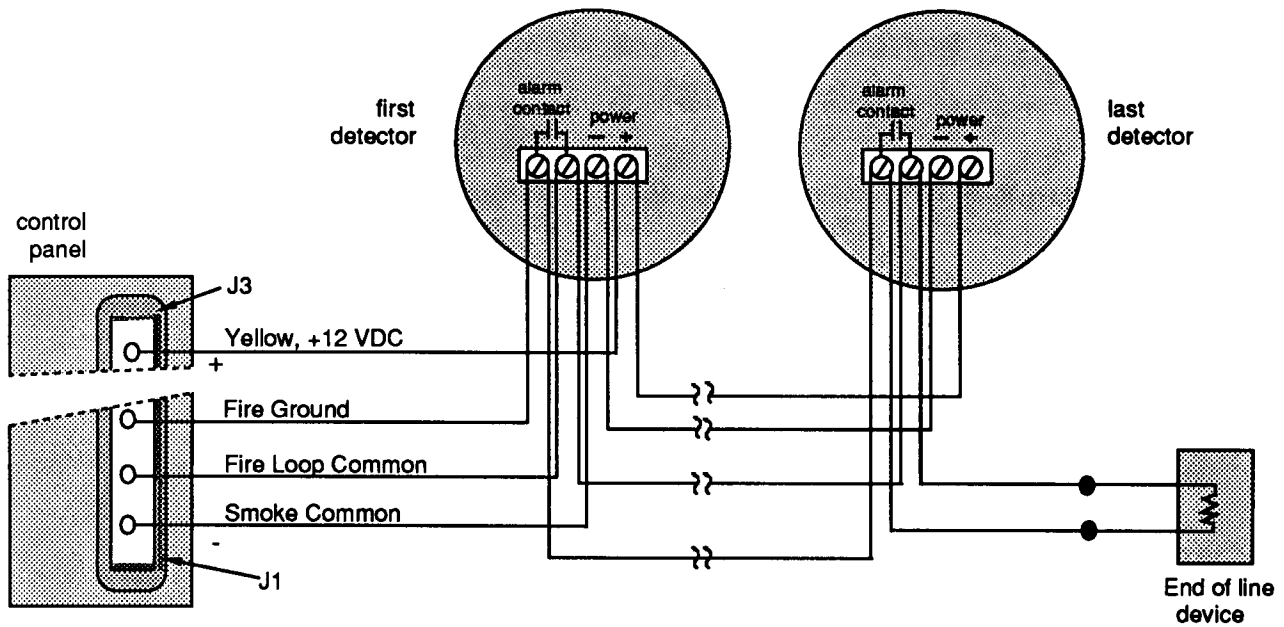

PROGRAMMING

Power up

The Control Panel is ready for power up when all the systems wiring has been completed as per the wiring diagram in this manual. Check to be sure there is proper connection between the zone wires and the systems quick connect wiring harnesses. Any wires not being used should be cut off (terminated) at the connector plug. If everything looks good, go through the following steps:

- 1 Plug the wiring harnesses into the proper connector sockets.*
- 2 Plug in the power transformer.*
- 3 Press the Status Button. The panel will perform a ROM test. If all of the LED's light for a few seconds, the test was successful. If the LED's remain off, the ROM test failed. (If the panel fails the ROM test, you should get a new software chip. Send your panel in to be replaced.) If the test is successful, the panel will make a long beep and return to the program mode with all LEDs flashing.*
- 4 Position the 9 V back-up battery by rotating the battery so the connectors are facing out and make the connection.*
- 5 Mount the Control Panel on the wall mounting plate.*
- 6 Insert the tamper screw and screw it in until the LEDs stop flashing.*

The Commander is ready to use from the factory. It comes pre-programmed with three Burglary zones, one audible Panic, one Fire zone, and three Touchpad Emergency zones—all of which are outlined in the "System Overview" section of this manual.

- If the system can be used with this factory pre-set program, proceed to the "TESTING" section of this manual.*
- Some installations may require additional programming to utilize all the systems features and functions. If this is the case, continue on.*

(Remember, all of the programmable functions listed can also be programmed from the CS-4000 Central Station Receiver.)

Manual Programming

Programmed data is displayed on the LEDs in Hexidecimal form as follows:

LED	VALUE	
POWER	8	If the "POWER" LED is on
READY	4	If the "READY" LED is on
STAY	2	If the "STAY" LED is on
AWAY	1	If the "AWAY" LED is on
NO DELAY	-	
FIRE	-	

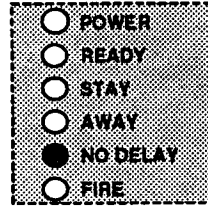

VALUE = 0

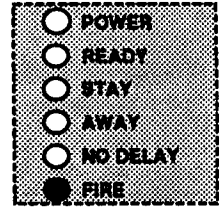

VALUE = 0

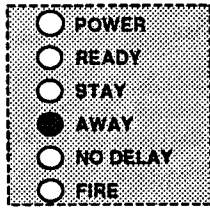

VALUE = 1

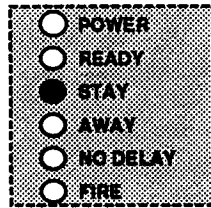

VALUE = 2

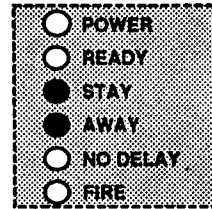

VALUE = 3

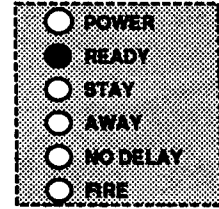

VALUE = 4



VALUE = 5

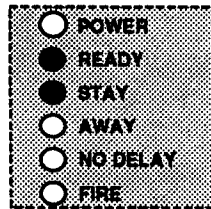

VALUE = 6

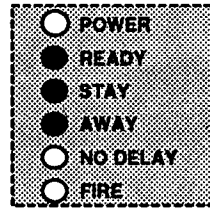

VALUE = 7

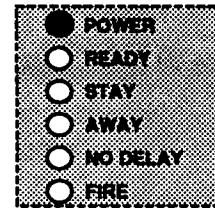

VALUE = 8

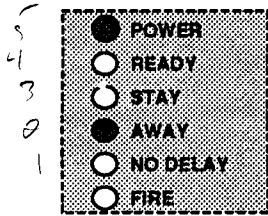

VALUE = 9

When the FIRE button is pushed, a value of 15 is displayed. This should be read as a pause or Null.

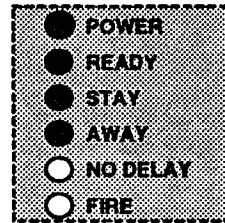

VALUE = 15

EXAMPLE BELOW: When the POWER and AWAY LED's are lit the Subfield has a value of 9. 8 plus 1 = 9.

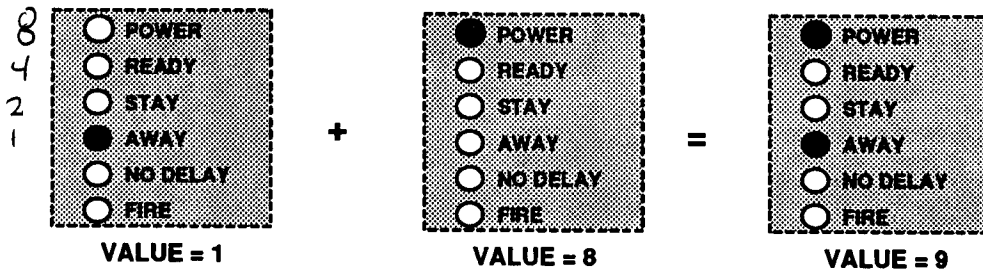

The "COMMAND" button is used to enter AND Advance the program.
 The "FIRE" button is used as F or null when programming the Central Station phone number into the system. When the "FIRE" button is pressed, all four LED's will be lit for a VALUE of 15. "NO DELAY" and "FIRE" LEDs should never be lit during programming.

TOUCHPAD PROGRAMMING

STEP 1:

- Disarm control panel. (The panel must be disarmed into level 1 or the panel will go into alarm)
- Back out tamper screw (bottom center of panel) until the panel beeps and all six LEDs start flashing.

STEP 2: Entering a field number

- The six flashing LEDs indicate the system expects a field number entry. Press the desired field number (1-9).
- The panel will flash the field number entered. If you change your mind just press another number.
- Press the "COMMAND" button to enter into the selected field. The panel will beep and display the value of the first subfield.

NOTE: If you enter an incorrect field number, the panel will make a long 2 second beep (error tone) and flash all six LEDs.

STEP 3: Read or enter a field

- The value displayed will be that of the first subfield in the field selected. If you wish to change the value just press the desired number on the touchpad.
- When you have the desired value for that subfield, press the "COMMAND" button to enter the value into the program and advance you to the next subfield.
- When you have stepped through all the subfields in the field the panel will blink the six LED's to signal the end of the field. It is ready for another field.

EXAMPLE: To change the siren time-out period from the factory set time of 4 minutes:

- Back out the tamper screw until all the LEDs on the panel are flashing.
- Select field 1, the AWAY LED will be flashing. Press COMMAND to enter field 1.
- Now, the first subfield (entry delay time) value will be displayed (3). (STAY and AWAY LED's lit.)
- Press COMMAND to accept (3) and advance to the second subfield, exit delay time.
- Another (3) will be lit, press COMMAND to accept (3) and advance to the third subfield.
- A (4) READY LED will be lit on the display. To change the value, simply press any number 1-9 to select a siren time-out period of 1-9 minutes.
- After you have selected the siren time-out period, press COMMAND to enter the number into memory and advance to the next subfield.
- In this case there are no additional subfields and the panel will exit the field and start flashing all six LEDs on the panel awaiting the next field selection.
- If there are no additional fields to program, exit the programming mode by turning the tamper screw in until the LEDs stop flashing and the panel beeps and returns to normal operation.

The following is a description of each field and subfield and their factory preset values:

FIELD	SUBFIELD	VALUE RANGE	DESCRIPTION
1	1) Entry delay time(10-90sec)	1-9	10 sec/step Default=3 (30 seconds)
	2) Exit delay time(10-90sec)	1-9	10 sec/step Default=3 (30 seconds)
	3) Siren time-out (1-9min)	1-9	1 min/step Default=4 (4 minutes)

FIELD	SUBFIELD	VALUE RANGE	DESCRIPTION
2	1) Touchpad Police Panic	1	Disabled
		3	Audible (Default)
		2	Silent
	2) Touchpad Medical Panic	1	Disabled
		2	Enabled (Default)
	3) Touchpad Fire Panic	1	Disabled
2		Enabled (Default)	
4) Fire Zone	1	Disabled	
	2	Enabled (Default)	
5) Built-In Siren	1	Silent for Intrusion, Police Panic and Tamper	
	2	Enabled (Default)	
6) Entry Delay Beeps	1	Soft (Default)	
	2	Loud	
	3	No entry delay beeps	
3	1) Duress Code (00- FF)	0-9, F	1st Digit FF (Default)
		0-9, F	2nd Digit
4	1) Account number (0000-99999) 70 700 690	0-9	1st Digit 00000 (Default)
		0-9	2nd Digit
		0-9	3rd Digit
		0-9	4th Digit
		0-9	5th Digit

NOTE: • The FIRE button shows a value of 15 on the LED display and is abbreviated as F.
• All F's = communicator is disabled.
• Trailing F's are ignored (nulls).
• Leading F's and F's in between digits are pauses or delays in the dialing sequence.

FIELD	SUBFIELD	VALUE RANGE	DESCRIPTION
5	1) Phone number 1	0-9, F	1st Digit Default=all F's
		0-9, F	2nd Digit
		.	.
		.	.
6	1) Phone number 2	0-9, F	1st Digit Default=all F's
		0-9, F	2nd Digit
		.	.
		.	.
		0-9, F	14th Digit

EXAMPLE: A typical central station toll free phone number would be: 800-123-4567. You would program the numbers : 18001234567FFF . In the event the panel is installed in a commercial location that requires a 9 to access an outside line, that number, would be which would be dialed as follows.: 9 (Pause for outside dial tone) 1-800-123-4567, would be programmed into the panel as follows: 9F18001234567F

FIELD	SUBFIELD	VALUE	RANGE	DESCRIPTION
7	1) Zone 1 exterior intrusion	1		Disabled
		2		NC, Delay (Default)
	2) Zone 2 options exterior intrusion	1		Disabled
		2		NC, Instant (Default)
		3		NC, Delay
	3) Zone 3 options interior intrusion	1		Disabled
		2		NC, Instant (Default)
		3		NC, Delay
		4		NO, Instant
		5		NO, Delay
	4) Zone 4 options exterior intrusion or panic	1		Disabled
		2		NO, Audible police panic (Default)
		3		NO, Silent police panic
		4		NO, Medical panic
		5		NC, Instant intrusion

NOTES TO ZONE OPTIONS:

- Zone 1 always NC delayed exterior intrusion
- NC=normally closed, alarm on open
- NO=normally open, alarm on close

FIELD	SUBFIELD	VALUE	RANGE	DESCRIPTION
8	1) Quick Arm Feature	1		Disabled
		2		Enabled (Default)
	2) Automatic test	1		Disabled (Default)
		2		1 Days
		3		7 Days
		4		28 Days
		5		84 Days
	3) Phone Options	1		Ph 2 not used (Default)
		2		Call Phone 2 if Phone 1 fails
		3		Call Phone 2 after Phone 1
	4) Open/Close Reports	1		None (Default)
		2		Close Reports
		3		Open Reports
		4		Open & Close Reports
	5) AC Power Reporting	1		Disable AC Fail/Restore Reports (Default)
		2		Enable AC Fail/Restore Reports
	6) Bypass Reporting	1		Disable Bypass Reports (Default)
		2		Enable Bypass Reports

<i>FIELD</i>	<i>SUBFIELD</i>	<i>VALUE RANGE</i>	<i>DESCRIPTION</i>
9	1) Touchtone key option	1 2	* key (Default) # key
	2) Touchtone police panic	1 2 3	Disabled Audible (Default) Silent
	3) Touchtone start time	1 2	Slow, 128 milliseconds (Default) Fast, 20 milliseconds

NOTE: The Touchtone start response time refers to the length of time the * or # button needs to be depressed in order for the control panel to recognize it.

NOTE: While in program mode, pressing the keys Status then Command will bring the panel back to its original factory pre-set condition.

PROGRAMMING the COMMANDER from CS-4000 CENTRAL STATION RECEIVER

Receiving Calls

The Commander Control Panel is capable of sending calls to the CS-4000. This system communicates to the Receiver in the standard ITI format. Calls from the Commander will be displayed in the same fashion as reports from an SX-IIIIV, SX-IVB or SX-V are received.

Example:

SUN MAY 15, 1988 16:28:24 #0067
ACCOUNT 54-321 Line 01
83 Phone Test
Protection Level Was 3 Now 0
Line 01 Released.

Possible Reports From CPU

The following is a list of the possible reports the Commander may send to the CS-4000.

01 ALARM!	Zone 1 - Entry doors (delayed) Zone
02 ALARM!	Zone 2 - Perimeter Delayed Burglary
02 ALARM!	Zone2 - Perimeter Instant Burglary
03 ALARM!	Zone 3 - Interior Instant Burglary
03 ALARM!	Zone 3 - Interior Delayed Burglary
04 ALARM!	Zone 4 - Audible Panic
04 ALARM!	Zone 4 - Silent Panic
04 ALARM!	Zone 4 - Medical
04 ALARM!	Zone 4 - Perimeter Instant Burglary
05 ALARM!	Zone 5 - Fire Zone
05 SUPERVISORY	Fire Zone Trouble

77 ALARM! CPU TAMPER	When 10 incorrect codes have been entered
80 ALARM!	Touchpad Fire Panic
81 ALARM!	Touchpad Police Panic
82 ALARM!	Touchpad Medical Panic
83 PHONE TEST	Initiated by customer to primary central station
84 OPENING REPORT User # "N"	When customer disarms the system
85 CLOSING REPORT User # "N"	When customer arms the system ,
86 ALARM! SILENT DURESS	
90 A/C FAILURE	After a 4 1/4 hr power failure when the panel goes to "sleep"
91 LOW CPU BATTERY	
92 ALARM! CPU TAMPER!	When panel is armed and tamper screw is removed
93 AUTOMATIC TEST	
95 A/C RESTORED	
nn CANCELLED	

Programming Commands

The Commander has a limited amount of interactive commands available for use. These include the following:

WHEN PROGRAMMING OPTIONS THE FOLLOWING COMMANDS MUST BE PRECEDED BY CM

Example - to program Entry Delay to 20 seconds, enter: CM ENTRY 2 <R>

THE OPTION	THE COMMAND	VALUE RANGE
Touchpad Siren	TPSiren	1-2
Touchpad Panic	TPPanic	1-3
Touchpad Medical	TPMedical	1-2
Touchpad Fire	TPFire	1-2
Fire Zone Enable	FIREoop	1-2
Zone 1 options	PERIM1	1-2
Zone 2 options	PERIM2	1-3
Zone 3 options	INTERlor	1-5
Zone 4 options	PANic	1-5
Touchtone key used	TTKey	1-2
Touchtone Panic Alarm	TTPanic	1-3
TT start response time	TTResp	1-2
Entry Delay Beeps	BEEPS	1-3
Quick Arm	QUickarm	1-2
Automatic Phone Test	TEST	1-5
Dialer Options	DIALer	1-3
Open/Close Reports	OPEN/Close	1-4
Bypass Reporting	RPTBYpass	1-2
AC Power Reporting	RPTACpower	1-2

NOTE: Please see Touchpad Programming Section for complete descriptions of options and value ranges.

~~DELETE "80" FPA~~ ← CM TPFIRE 1 } DELETED
~~DELETE 25 SMOKE~~ ← CM FIREOOP 1 }

WHEN PROGRAMMING OPTIONS, THE FOLLOWING COMMANDS SHOULD NOT BE PRECEDED BY CM

THE OPTION	THE COMMAND	VALUE
Entry Delay	ENTRY	1-9
Exit Delay	EXIT	1-9
Siren Timeout	TIMEOUT	1-9
User access code	ACCESS	NNNN
Duress code	DUress	NN
Account number	ACCOunt or ACCT	NNNNN
Multiple Access Code	MAccess	U CODE (U = User #2-6)
Primary phone number	PHone	NNNNNNNNNNNNNNN
Secondary phone number	PHONE 2 or PHO2	NNNNNNNNNNNNNNN
Set Auto Test Time	STime	N:NN
Download panel	UPDATE	
Panel Hangup & Call back	RECall	
Release Panel	RELease	
Answer a Phone Line	ANswer	
Erase Temporary CS Memory	ERase	
Trap an Incoming Line	TRap	

Notes on Cancelled Reporting:

1. Most alarms will stop dialing and will not report at all if the customer enters his panel code before the last digit of the phone number is dialed.
2. If the alarm is cancelled after the last digit is dialed but before the call to the central station is complete, both an ALARM and a CANCELLED report will be received.
3. If the alarm is cancelled after the central station receiver has released the line but while the sirens are still sounding the control panel will call again and a CANCELLED report will be received.
4. If the alarm is cancelled after the sirens have stopped sounding no cancelled report at all will be sent to the central station.

Exceptions To The Above:

1. Silent Panic alarms will not stop dialing and will never send a cancelled report.
2. Fire will not stop dialing, but can be cancelled by entering the access code. In other words, fire alarms cancel like most others except that if a user attempts to cancel a fire alarm the call will not be stopped even if he does so before the last digit of the phone number is dialed. Thus, you should verify a fire alarm if you receive a ALARM and a CANCELLED report on the same call.

Typing In the Programming

When typing in the programming, wait until the CS-4000 tells you it's ready, then type the commands. To get a complete display type CM and return. To get a specific value, type the code of that function and press return. For instance, if you want to find the value of the Fire Loop: wait until the display says READY, then type CM FireLoop. The display should read out FireLoop = 2. The following is a complete readout:

TYPE	DISPLAY
CM (Return)	Perim1 = 2
	Perim2 = 2
	Interior = 2
	Panic = 2
	QuickArm = 2
	Test = 1

TYPE	DISPLAY
<i>CM (Return)</i>	<i>Dialer = 1</i> <i>Open/Close = 1</i> <i>RptACPower = 1</i> <i>RptBypass = 1</i> <i>TPanic = 2</i> <i>TPMedical = 2</i> <i>TPFire = 2</i> <i>FireLoop = 2</i> <i>TPSiren = 2</i> <i>Beeps = 1</i> <i>TTKey = 1</i> <i>TTPanic = 2</i> <i>TTResp = 1</i>
<i>ENTRY</i>	<i>2 (x10)</i>
<i>EXIT</i>	<i>2 (x10)</i>
<i>TIMEOUT</i>	<i>8</i>
<i>ACCESS</i>	<i>ACCESS 1234</i>
<i>MACCESS</i>	<i>02 Not Initialized</i> <i>03 Not Initialized</i> <i>04 Not Initialized</i> <i>05 Not Initialized</i> <i>06 Not Initialized</i>

For example, if entering User Access Code 5:

<i>MACCESS 5 5678</i>	<i>02 Not Initialized</i>
	<i>03 Not Initialized</i>
	<i>04 Not Initialized</i>
	<i>05 5678</i>
	<i>06 Not Initialized</i>

To de-activate User Code 5:

<i>MACCESS 5 OFF</i>	<i>02 Not Initialized</i>
	<i>03 Not Initialized</i>
	<i>04 Not Initialized</i>
	<i>05 Not Initialized</i>
	<i>06 6969</i>

PROTECTION LEVELS

Before attempting any arming or disarming of your system, make sure all protected doors and windows are closed.

ACCESS CODES

The ACCESS CODE is your personal key to using the Commander. By entering this four digit identification code on your touchpad or your Touchtone phone (if equipped with the Telephone Control Module) you can select any of the protection levels, test your system, etc. A Secondary Access Code is also available for any frequent visitors to your home, such as service-people or babysitters, etc. Four more auxiliary access codes are also available.

LEVEL "1" OFF (1 Long Beep)

All burglary protection is disarmed. All 24 hour detectors including Touchpad "Fire", "Police" and "Emergency" are armed in Levels "1" through "8". Level 1 should be selected to cancel an accidental alarm. To disarm:

- 1 Enter your personal access code.
- 2 Press the OFF (#1) button.
- 3 Listen for one long beep.

LEVEL "2" STAY (2 Short Beeps)

All perimeter doors and windows will be armed. A delay period (factory set at 30 seconds) will allow you time to enter or leave a protected area. To arm when staying at home:

- 1 Enter your personal access code.
- 2 Press the STAY (#2) button.
- 3 Listen for 2 short beeps.

LEVEL "3" AWAY (3 Short Beeps)

All sensors (both exterior and interior) will be armed. A delay period (factory set at 30 seconds) will allow you time to enter or leave a protected area. To arm when leaving home:

- 1 Enter your personal access code.
- 2 Press the AWAY (#3) button.
- 3 Listen for 3 short beeps.

LEVEL "4" NO DELAY (1 Long Beep)

After you have entered into either level 2 or level 3, you can remove the delay time for entrance. To arm with no delay:

- 1 Enter your personal access code.
- 2 Press the STAY (#2) or AWAY (#3) button.
- 3 Listen for the acknowledging beeps.
- 4 Immediately press the NO DELAY (#4) button.
- 5 Listen for 1 long beep.

LEVEL "5" PROGRAMMING A NEW PRIMARY ACCESS CODE (1 Long Beep)

With the system in level "1" OFF, it is possible to program in a new Access Code Number.:

- 1 Enter your current access code plus "5" .
- 2 You will hear one long beep.
- 3 Enter your new 4 digit access code number.
- 4 You will hear one long beep signalling acceptance.

NOTE: The entering of a new code must take place within eight (8) seconds of pressing the "5".

LEVEL "6" SECOND ACCESS CODE (1 Long Beep)

May be used to change the Secondary Access Code number.

- 1 Enter the current Primary Access Code plus 6.
- 2 You will hear one long beep.
- 3 Next, enter the 4 digit Second Access code.
- 4 You will hear one long beep signalling acceptance.

THIRD ACCESS CODE (1 Beep)

- 1 Enter the Primary Access Code plus 6.
- 2 Press the Medical Emergency key.
- 3 Enter the four digits of the Third Access Code.
- 4 You will hear one long beep signalling acceptance.

TO DISABLE ACCESS CODE 3:

Follow the above steps 1 through 2, then press the COMMAND button. You will hear one long beep and Access Code 3 will be erased.

FOURTH ACCESS CODE (1 Beep)

- 1 *Enter the Primary Access Code plus 6.*
- 2 *Press the Fire Emergency key.*
- 3 *Enter the four digits of the Fourth Access Code.*
- 4 *You will hear one long beep signalling acceptance.*

TO DISABLE ACCESS CODE 4:

Follow the above steps 1 through 2, then press the COMMAND button. You will hear one long beep and Access Code 4 will be erased.

FIFTH ACCESS CODE (1 Beep)

- 1 *Enter the Primary Access Code plus 6.*
- 2 *Press the Police Emergency key.*
- 3 *Enter the four digits of the Fifth Access Code.*
- 4 *You will hear one long beep signalling acceptance.*

TO DISABLE ACCESS CODE 5:

Follow the above steps 1 through 2, then press the COMMAND button. You will hear one long beep and Access Code 5 will be erased.

SIXTH ACCESS CODE (1 Beep)

- 1 *Enter the Primary Access Code plus 6.*
- 2 *Press the Status key.*
- 3 *Enter the four digits of the Sixth Access Code.*
- 4 *You will hear one long beep signalling acceptance.*

TO DISABLE ACCESS CODE 6:

Follow the above steps 1 through 2, then press the COMMAND button. You will hear one long beep and Access Code 6 will be erased.

LEVEL "7" CHIME

The Chime feature lets you know if any protected door or window is opened or closed by sounding a gentle chime tone. This is especially helpful if you have small children or pets. Chime is only active if your system is not armed to any other protection level. To activate the Chime feature:

- 1 Enter your access code and 7.*
- OR*
- 2 Enter COMMAND-7*
- 3 Chime will stay active until you turn it off by entering the Chime command a second time*

LEVEL "0" LIGHT CONTROL (1 Long Beep)

At any time, in any protection level, you can control specific lights in your home or business.

- 1 Enter your 4 digit access code number plus "0" (or COMMAND-0).*
- 2 You will hear one long beep and the controlled lights will turn on.*
- 3 After 15 minutes the controlled lights will turn off.*
- OR*
- 4 If you enter your 4 digit access code number plus "0" again before the 15 minutes are up, the controlled lights will turn off.*

NOTE: *With the Light Control Module, the lights will come ON for a period of 100 seconds whenever the panel is armed. The lights will also come ON during Entry and Exit times. During **FIRE** alarms, the Light Control Module will turn the controlled lights on steady indefinitely or until 20 seconds after the panel is disarmed. During **POLICE** alarms, the controlled lights will flash on and off indefinitely or until 20 seconds after the panel is disarmed. After the panel is disarmed, the lights will go from flashing to steady for the 20 second period following a **POLICE** alarm.*

SYSTEM ALARM AND STATUS SOUNDS

Interior Sirens

The interior siren is built into the Commander Control Panel and is intended to alert you of an emergency and frighten away an intruder. The following is a summary of the interior alarm sounds:

ALARM SOUNDS:

Fire Alarm - loud steady tone siren

Police Alarm - loud On-Off tone siren

Emergency Alarm - low volume, on-off-on-off beeping, rate of beeping slows upon receipt by Central Station.

STATUS SOUNDS

The following is a summary of the low level status sounds heard from the Commander :

One Beep	Indicates that you have successfully accomplished the task you have attempted, including disarming to level 1.
Two Beeps	Sounds when system is armed to level 2 and when exit delay ends.
Three Beeps	Sounds when system is armed to level 3 and when exit delay ends.
Repeated 2 Or 3 Beeps	Entrance delay pre-alarm warning sound. (Repeated single beeps during entrance delay time if an alarm is in memory.)
Fast Beeps	Sound as long as a zone is violated in Sensor Test (level 9).
Spaced Beeps	Indicates successful receipt by the Central Station of a Phone Test (level 8).
Long Low Tone -2 Seconds -	Error Tone. Attempt to arm with a zone open, invalid entry during programming.
Beep Every 15 Seconds	TROUBLE INDICATION- Indication of a low battery, open fire zone, a fire zone that has not reset or that a new alarm is in memory. Stops if access code is used. Repeats in 24 hours if fault still exists.
Blip	Touchpad number pressed.

Exterior Sirens

Exterior Sirens can be placed in various locations on the outside of your home or business to frighten away an intruder and alert you and your neighbors of an emergency. Exterior Sirens can also be placed on the inside of your home or business for added volume to your emergency alarm sounds. The maximum number of Outside Sirens is one. The maximum number of Phone Jack Sirens for inside use is one when installed with an Outside Siren and two if no Outside Siren is installed. The following is a summary of the exterior siren sounds:

Fire Alarm - loud steady buzzing tone siren.

Police Alarm - loud On-Off buzzing tone siren.

UNDERSTANDING THE DISPLAY

All the detection zones in your Commander are continuously monitored. Any type of trouble or open detection zone will be displayed on the front of the Control Panel in the form of 6 LED display. If your system is connected to a Central Station Monitoring Station, The Control Panel will also notify the Central Station.

POWER - When ON, AC power is ON and the back-up battery is good. When FLASHING, AC power is ON but the back-up battery is BAD. When OFF, the AC power is OFF.

READY - When on, exterior and interior zones are ready to be armed. When off, the system can not be armed.

STAY - When on, system is armed to level 2, exterior protection only.

AWAY - When on, system is armed to level 3, full protection.

NO DELAY - When on, there are no delays set.

FIRE - When on, system is showing a fire alarm. The light will stay lit until fire zone is reset. When flashing, the fire zone is open OR the fire zone has not reset. When off, normal operation. The Fire zone can go into alarm even if it is in a fault condition.

Status LEDs

The LEDs can also act as system status indicators. If the READY LED is not lit and the STATUS button (located under the door above the siren on the control panel) is pressed, the flashing LEDs will show which zone or zones are open. For example, if a door in zone 1 was left open, the READY LED would be off. At that time, press the STATUS button and all the LEDs would be off except the first LED, zone 1.

Alarm Memory LEDs

The LEDs can also act as an alarm memory indicator. After a new alarm has occurred, the first 5 LEDs will scroll up and down, indicating that an alarm occurred while the system was armed and an alarm is in memory. The scrolling LEDs will stop as soon as the Command-Status button is pressed. The memory will not change until there is another alarm in another arming period. When the COMMAND then STATUS button is pressed, the alarm memory LEDs indicate for the next 8 seconds which zone was in alarm. The first zone violated will flash, all following zones violated will light steady. If an alarm occurs while the system was in levels 2 or 3, the Control Panel will sound fast steady beeps during the entry delay time, to act as further indication that a new alarm is in memory.

Spaces have been provided behind the panel door for zone identification information.

SPECIAL FEATURES

COMMAND BUTTON or "QUICK ARM " FEATURE

The **COMMAND** Button or "Quick Arm" feature can take the place of the full access code in entering your protection levels on the touchpad. **COMMAND** may only be used in place of the full code when arming to a higher protection level. If you wish to reduce protection, the full code must be used.

PRESS	LEVEL
COMMAND-2	arms to Level 2
COMMAND-2-4	arms to Level 2 instant
COMMAND-2 COMMAND-4	arms to Level 2 instant
COMMAND-3	arms to Level 3
COMMAND-3-4	arms to Level 3 instant
COMMAND-3-COMMAND-4	arms to level 3 instant

ALARM MEMORY BUTTON

Press **COMMAND** plus the **STATUS** button at any time and for the next 8 seconds the **LED's** will display information about the last arming level in which there were alarms reported. A flashing **LED** indicates the first zone violated and steady **LED's** will indicate any additional zones violated.

CHANGING ACCESS CODES

To change your access code, simply enter Code + 5 + New Code to change your Primary Code and Code + 6+ New Code to change your Secondary Code. See Protection Level section for Auxiliary Access Codes 3-6 for programming.

EMERGENCY ALARM BUTTONS

If you have an emergency you can sound the sirens and notify the Central Monitoring Station by pressing the emergency buttons on your Control Panel.

POLICE PANIC Press **POLICE** button twice within 3 seconds or hold for 3 seconds.

FIRE PANIC Press **FIRE** button twice within 3 seconds or hold for 3 seconds.

EMERGENCY PANIC Press **EMERGENCY** button twice within 3 seconds or hold for 3 seconds.

LIGHT CONTROL

With the Light Control Module, the lights will come **ON** for a period of 100 seconds during Entry and Exit times. During **FIRE** alarms, the Light Control Module will turn the controlled lights on steady indefinitely or until 20 seconds after the panel is disarmed. During **POLICE** alarms, the controlled lights will flash on and off indefinitely or until 20 seconds after the panel is disarmed. After the panel is disarmed, the lights will go from flashing to steady for the 20 second period following a **POLICE** alarm.

CHIME FEATURE

When the Chime Feature is activated, a gentle chime tone will sound whenever a protected door or window is opened. This is an especially helpful feature for those with young children or pets.

ZONE BYPASSING

If you wish to arm your system with a door or window open, enter one of the Bypass arming sequences shown below. The panel will arm with any exterior zones that are currently violated (open) set to Bypass. Bypassed zones are ignored until disarmed. While the panel is armed with any zones bypassed, the "STAY" or "AWAY" **LED** will blink to remind you that Bypass is in effect. To restore the zones, you can disarm or clear the Bypass and rearm by entering a normal arming code (CODE-2 or CODE-3, etc.)

You must use a code to arm in the Bypass mode. The Quick-Arm feature cannot be used to Bypass or restore zones. The interior zone (Zone 3) and the Fire Zone may never be bypassed. For Zone 3, simply arm to level 2, STAY.

Bypass Arming Codes

With the zone open and the READY LED off, press:

CODE-COMMAND-2	arms to level 2 Bypass
CODE-COMMAND-2-4	arms to level 2 Bypass, No Delay
CODE-COMMAND-3	arms to level 3 Bypass
CODE-COMMAND-3-4	arms to level 3 Bypass, No Delay

If any alarms occur while Bypass is in effect the panel will report the alarm and report an 87 alarm along with the status of each zone currently bypassed.

OPTIONAL TOUCHTONE™ TELEPHONE ARMING

As an option to your Commander, your house phones can be used for arming, disarming, status, Police panic, and light control. With this module you would use the same access code as usual, except it would be preceded with either a * or a #. Whether a * or a # is used is a programmable function. If the telephone were in use and someone needed to perform any of the available functions, once the * is pressed the phone conversation is put on hold temporarily until the arming sequence is over.

ARMING

From an on premise TouchTone™ telephone simply enter * + CODE + 2 or * + CODE + 3 and if the system was disarmed, it will arm and either 2 or 3 beeps will be heard from the Control Panel and over the phone.

In addition, the system can be armed with no time delay by adding a 4 to the end of the arming sequence within 8 seconds of arming. A single long beep will be heard.

DISARMING

From an on premise TouchTone™ telephone simply enter * + CODE + 1 and if the system was armed, it will disarm and 1 beep will be heard from the Control Panel and over the phone.

PANIC

From an on premise TouchTone™ telephone simply press the * button (or the # button if so programmed) 6 times (* * * * *) in succession, allowing 1/4 second depression for each * button, and a Police panic alarm will be initiated and the Central Monitoring Station will be notified.

STATUS

From an on premise TouchTone™ telephone simply press " * 411 " and you will hear 1,2, or 3 beeps indicating which protection level the system is armed to. You will not be able to tell if the entrance delay is set or not, unless you look at the LED on the Control Panel.

NOTE: All examples are being shown using a "*". Your system may be programmed with the "#" KEY in place of "*"

LIGHT CONTROL

From an on premise TouchTone™ telephone simply press * + 412 and the system will turn on lights connected to X-10 Powerhouse units for 15 minutes and then automatically turn them off. If within the 15 minute time frame, * + 412 will turn off the lights. * + CODE + 0 may also be used. From the Control Panel, you may control the lights in the same manner using CODE+ 0 (zero).

CHIME FEATURE

To activate the Chime Feature using an on premise touchtone phone, simply press * + CODE + 7. Remember, the system cannot be armed to any other level when using this feature. Press * + CODE + 7 again to deactivate the Chime.

HOW TO TEST YOUR SYSTEM

To assure continued protection, all systems must be tested regularly. We recommend that you test your system at least once each week. The Commander has two testing levels that are easily accessed by first entering your personal access code and then the desired testing level.

PROTECTION LEVEL TEST

The first step in testing the Commander is to arm and disarm the system. Make sure that you can arm the system into every possible protection level. When arming the system, be sure that the POWER and READY LEDs are lit. If the READY LED is off, check to see that all zones are in an un-violated state, closed for normally closed zones and open for normally open zones. If the READY LED is out or flashing indicating a zone violation, press the STATUS button. The corresponding LED will blink indicating the zone or zones in violation.

COMMUNICATIONS TEST

If you intend to have the system monitored, all that is necessary for communications is to be connected to a properly installed RJ31X, and the proper central station phone number programmed into the panel. The panel will remain a local alarm until a central station phone number is programmed. To test communications with the correct number programmed into the panel, simply enter the access code number then 8. When the central station receives the test signal, the panel will make four short evenly spaced beeps. If you want the central station to program the account number and phone number for you, call the central station and tell them the phone number the panel is connected to. At that time they will call you back and ask for a test signal. Simply enter the access code and 8. Wait 30 seconds before you hang up the phone. Wait for the call back from the central station. Now, test the Emergency Panic buttons on the control panel making sure they give the correct annunciation and that the signals are received by the central station.

LEVEL "8" PHONE TEST (1 Long Beep)

Level 8 tests the optional communication link between your system and the Central Monitoring Station. The Phone Test is complete when the Central Station causes your system to sound 4 evenly spaced beeps, and the display LEDs stop flashing on and off.

LEVEL "9" SENSOR TEST (1 Long Beep)

Level 9 is used to test the communication link between the detection sensors and the Control Panel. Each time a sensor is violated, and until the violated sensor is restored, the Control Panel will sound rapid beeps. The display LEDs will flash on and off during Sensor Test. If any sensor does not test properly, immediately call your installing dealer.

ALARM MEMORY TEST

After you have set off several alarms, disarm the system and test the panel for alarm memory retention. With the system in level 1 "OFF" press COMMAND and STATUS button. The LEDs will display with a flashing LED next to zone that first went into alarm, and steady on LEDs next to all other zones violated during that alarm period. The panel will retain the alarm information until it is replaced with another alarm. The following is a diagram of how the indicator LEDs correspond to the zones:

- | | |
|------------|--|
| • POWER | Zone 1 (Time Delay Doors) |
| • READY | Zone 2 (Perimeter) |
| • STAY | Zone 3 (Interior) |
| • AWAY | Zone 4 only |
| • NO DELAY | Any Touchpad Panic, Telephone Panic, Touchpad or CPU Tamper. |
| • FIRE | Zone 5 (fire detectors) |

STAND-BY POWER TEST

The system does a dynamic battery test every 24 hours and after initial programming on it's own. To manually test the stand-by power, simply unplug the class II power transformer and arm and disarm the system. The "POWER" LED should be out and the system should still operate.

LIMITED WARRANTY

Equipment and products manufactured by Interactive Technologies Inc. (ITI) (Except the SX-IV Security System which is covered by another warranty) are warranted to be free from defects in material and workmanship for at least a two (2) year period. The warranty expiration date is indicated by the month and year and/or serial number on the product and is equal to or greater than two (2) years from the date of purchase. ITI's obligation under this warranty is limited to the repair or replacement of any defective products or equipment, including parts or components, which become evident during the term of this warranty, if the product or equipment claimed to be defective is returned to ITI at the buyer's expense within the warranty period, along with a written notice explaining the claimed defect in reasonable detail. This Limited Warranty does not cover batteries of any type or parts requiring replacement as a result of normal wear and tear, catastrophe, fault or negligence of user or the wholesale buyer, improper use of the equipment or other causes external to the products or equipment.

This Limited Warranty extends only to wholesale customers who buy directly from ITI. ITI does not warrant its products to consumers or end users. Consumers or end user should inquire from their selling dealer as to the nature and extent of the dealer's warranty, if any.

Defective units, returned to ITI by the buyer at his own expense during the warranty period, will be repaired or replaced at the options of the manufacturer with an equivalent piece of remanufactured and tested equipment. The repaired or replaced equipment is then warranted under the terms of this Limited Warranty or for ninety (90) days, whichever is longer.

Correction of such defects by repair or replacement of such parts or components shall constitute the fulfillment of all warranty obligations of ITI. ITI shall not be liable for any loss, damages or expenses directly or indirectly arising out of, or in connection with, the use or performance of the products or other indirect damages with respect to loss of property, revenue, or profit, or cost of removal, insallation and reinstallation.

THE FOREGOING LIMITED WARRANTY IS IN LIEU OF ALL OTHER WARRANTIES, EXPRESS OR IMPLIED, INCLUDING, BUT NOT LIMITED TO, ANY IMPLIED WARRANTIES OF MERCHANTABILITY OR FITNESS FOR A PARTICULAR PURPOSE. NO PERSON (INCLUDING ANY AGENT, DEALER OR REPRESENTATION OR WARRANTY CONCERNING THE MANUFACTURER'S PRODUCTS EXCEPT TO REFER PURCHASERS TO THIS LIMITED WARRANTY. FURTHER, ANY IMPLIED WARRANTIES (INCLUDING, WITHOUT LIMITATION, ANY IMPLIED WARRANTIES OF MERCHANTABILITY OR FITNESS FOR A PARTICULAR PURPOSE) ARE LIMITED TO THE DURATION OF THIS LIMITED WARRANTY. SOME STATES DO NOT ALLOW LIMITATION ON HOW LONG AN IMPLIED WARRANTY LASTS, SO THIS LIMITATION MAY NOT APPLY TO YOU.

THE PURCHASER'S EXCLUSIVE REMEDY WITH RESPECT ANY AND ALL LOSSES OR DAMAGES RESULTING FROM ANY CAUSE WHATSOEVER, SHALL BE REPAIR OR REPLACEMENT, AS SPECIFIED ABOVE. MANUFACTURERS SHALL IN NO EVENT BE LIABLE FOR ANY CONSEQUENTIAL OR INCIDENTAL DAMAGES, HOWEVER OCCASIONED, WHETHER BY NEGLIGENCE OR OTHERWISE. NO SUIT FOR ACTION SHALL BE BROUGHT AGAINST MANUFACTURER MORE THAN ONE (1) YEAR AFTER ACCRUAL OF THE CAUSE OF ACTION THEREFOR. SOME STATES DO NOT ALLOW THE EXCLUSION OR LIMITATION OF INCIDENTAL OR CONSEQUENTIAL DAMAGES, SO THIS LIMITATION OR EXCLUSION MAY NOT APPLY TO YOU.

THIS WARRANTY GIVES YOU SPECIFIC LEGAL RIGHTS, AND YOU MAY ALSO HAVE OTHER RIGHTS WHICH VARY FROM STATE TO STATE.



Interactive Technologies Inc., 2266 North Second Street, North St Paul, MN 55109

FEDERAL COMMUNICATIONS COMMISSION REGULATIONS

This equipment is in compliance with Federal Communications Commission (FCC) Part 15, Subpart J, Class B and Part 68 where applicable. Each device carries a label giving the specifics and conditions of compliance. The FCC requires that you be informed of the following:

This equipment complies with FCC Rules Part 15. Operation is subject to the following two conditions: (1) this equipment may not cause harmful interference and (2) this equipment must accept any interference that may be received, including interference that may cause undesired operation.

For additional help, consult your dealer or an experienced radiotelevision technician. See also the FCC booklet, "How to Identify and Resolve Radio-TV Interference Problems." This booklet is available from the U.S. Government Printing Office, Washington D.C. 20402. Stock No. 004-000-00345-4.

NOTES:

Product specifications subject to change without notice.



*Interactive Technologies, Inc
2266 North Second Street
North St Paul, MN
US & Canada Toll Free: (800) 331-0400
In Minnesota: (612) 777-2690*

*Rev. 8/89
(Part Number 46-104)*

Commander III[®]

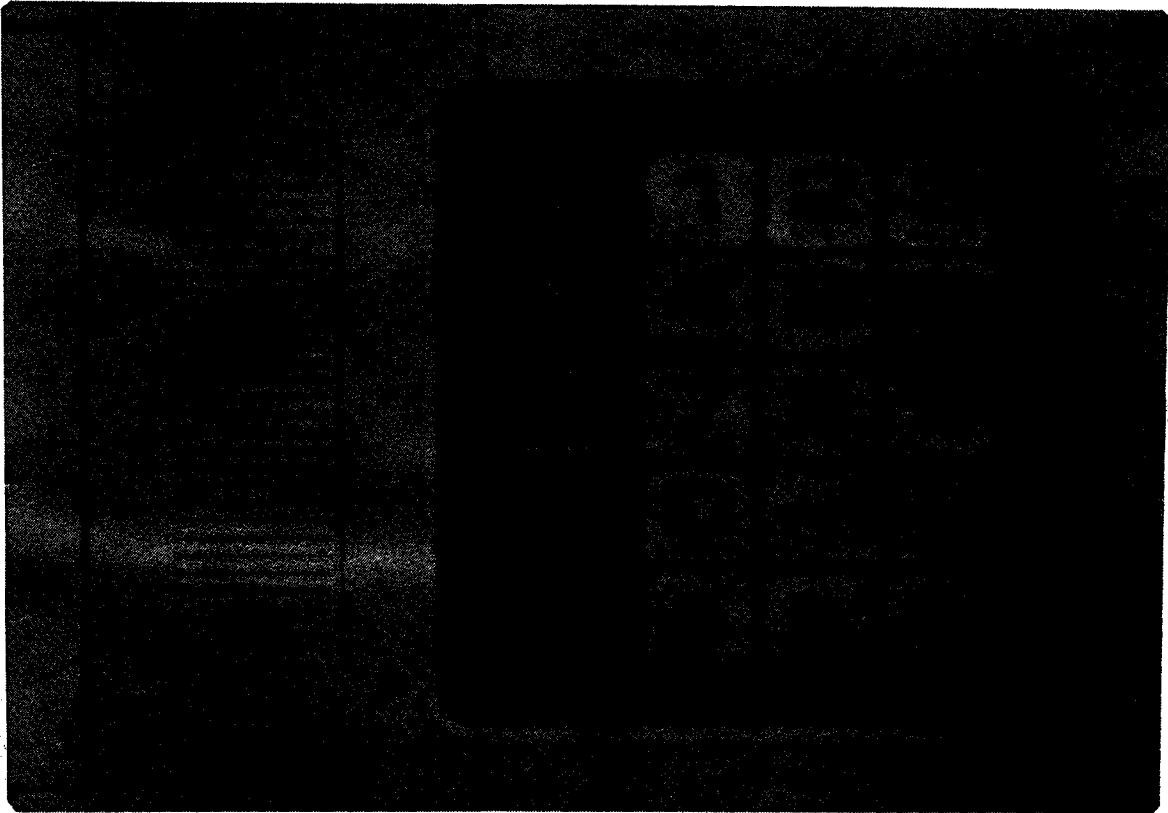

ITI FORMAT

ONLY
NO 4x2

REFERENCE and INSTALLATION MANUAL